

**EVERGREAT**

**永大機械股份有限公司**  
EVERGREAT MACHINERY CO., LTD.

# DIE CASTING MACHINE

[www.evergreatmc.com.tw](http://www.evergreatmc.com.tw)

150~800 噸 / Tons 壓鑄機



## 永大機械股份有限公司

EVERGREAT MACHINERY CO., LTD.

台南市永康區南興路48巷76號

No.76, Lane 48, Nanshing Rd.,

Yongkang Dist., Tainan City 71064, Taiwan

TEL: +886-6-2725358

FAX: +886-6-2714009

E-mail: evergreat168@gmail.com

## 永大機械(深圳)有限公司

YOTA MACHINE (SHENZHEN) CO., LTD.

廣東省深圳市寶安區石岩鎮水田村第三工業區創業路17號

Shi Yan Town, Bao An District, Shenzhen City, China

TEL: +86-755-29684862 29684863

FAX: +86-755-29684513

[www.evergreatmc.com.tw](http://www.evergreatmc.com.tw)

14883.1000.03.2021.CE



# EVERGREAT

## Die Casting Machine

永大壓鑄機



Taiwan / 台灣

Your best choice for  
die casting machines  
創新設計 / 鑄品品質穩定



Shenzhen / 深圳

EVERGREAT Machinery was founded in Yongkang District, Tainan City in 1964. Starting as a plastic foundry, the company transformed into a manufacturer specializing in cold-chamber die casting machines. As our business scale gradually expanded, we set up our first branch in Shenzhen City, Guangdong Province in 1999 as the entry to the China mainland market.

On the journey of manufacturing for more than half a century, we have accumulated experiences through generations to develop our trusty die casting machine techniques. Our customers can get the highest quality at the most affordable price from EVERGREAT. It is our biggest achievement to help our customers improve their competitiveness through our products.

In addition to die casting machines, we have also developed peripheral equipment. We provide one-stop shopping & total solution service for your die casting production. Also, we provide complete after-sales service. After the machine is shipped, we will send professionals to our customers for installation and provide a warranty.

EVERGREAT is aiming at standing by our customers with our firm techniques. Our well-equipped facilities and excellent systematic management enable us to guarantee our customers' satisfaction. Additionally, we have our engineers go abroad to learn the new technologies so that we can continue to surpass our customers' expectations.

永大機械股份有限公司自1964年發跡於台南永康，成立初期以塑膠代工為主，隨後投入技術門檻更進階的鋁合金冷室壓鑄機，事業規模逐漸擴大的永大機械，於1999年在廣東省深圳市設立分公司並投入中國大陸市場。

如今已累計超過半世紀的壓鑄機設計製造經驗，世代傳承的技術使得我們擁有獨一無二深厚的底子。我們有信心，客戶能夠在我們公司以最經濟實惠的價格獲得最優質的產品，最大的成就便是來自於透過我們的產品幫助客戶提升競爭力。

除了打造品質穩定、高性能的壓鑄機之外，亦研發出全系列週邊設備，永大提供您壓鑄產線的全方位解決方案。同時，我們提供完整的售後服務，於機台完成後隨即派遣專業人員至客戶端進行裝機，並提供保固期，讓顧客沒有後顧之憂。

永大機械擁有完善規劃的寬敞庫房，以系統化的方式進行倉儲管理，能夠精準掌控零組件庫存量並最佳化製造流程。此外，工程師不定期飛往國外學習新技術，致力於追求技術的突破與創新，幫助客戶面對當今企業經營之新挑戰。

# Machine Structure

## Superior Rigidity & Minimum Deformation

### 機體結構

高剛性，不變形 / 耐重負荷

The structure of EVERGREAT die casting machines is optimized by analyzing and designing with effort.

永大全系列壓鑄機之機體結構均經過精心分析設計，以達到最佳結構強度，耐重負荷且多年不變形。

### Oversized Tie Bar

The design eliminates stress, which provides extra durability and extends service life.

大尺寸大柱  
超大尺寸之大柱經應力消除，強度高、使用壽命長。

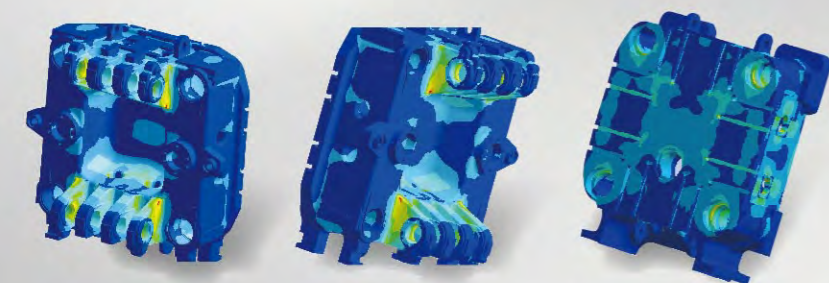

Stress analysis on mold platen 機器模壁應力分析

### Rigid Toggle Mechanism

The toggle mechanism makes a perfect match with thick die platens. It ensures the accuracy for the parallelism between die platens.

### 高剛性曲手機構

特殊設計的曲手機構，機板厚度加厚，除了大幅增加鎖模時之剛性與穩定性，而且確保機壁面的平行精度。

### Integrated Injection Unit

The design ensures both C-shaped frame and front platen align with the injection center, thus providing excellent injection performance.

### 一體式射出C型結構

獨特設計的前機壁與C型架為一體鑄造成型，可確保射出中心的一致性，更可徹底發揮優異的射出性能。

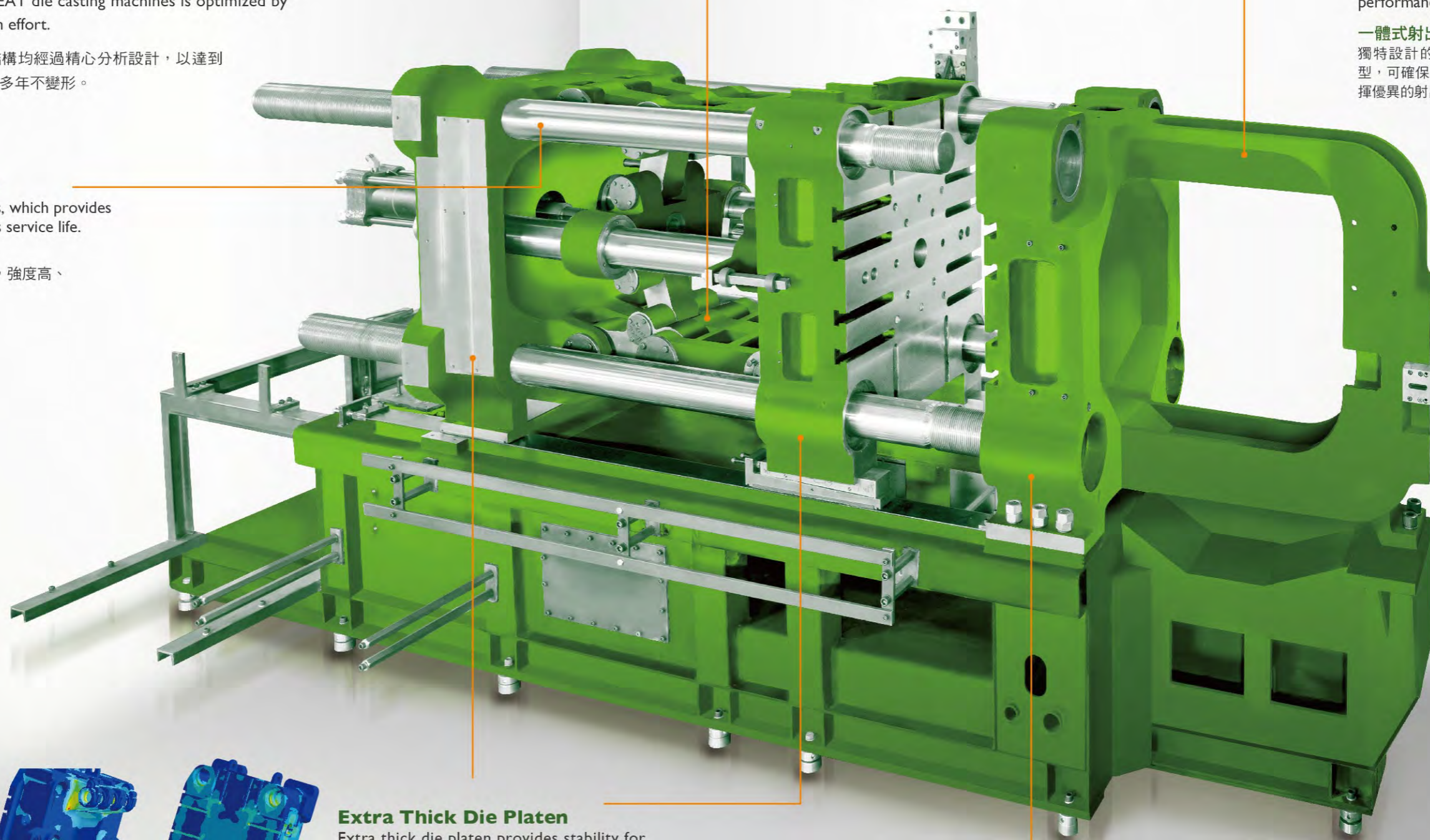

### Extra Thick Die Platen

Extra thick die platen provides stability for die clamping and rigidity to keep deformation to a minimum.

### 加厚機壁

機壁加厚，提升鎖模穩定性及剛性，將變形量降至最低。

# Control System

## 電控系統



## ● Full Test™ Mold Flow Analysis Full Test™ 實機模流分析

Full Test™ analysis simulates the die casting process with multi-stage injection control. The function helps an operator to observe flow of aluminum liquid during forming and to make a corresponding solution, and thus making sure to achieve a fully-filled barrel before second-phase injection.

In the cold chamber die casting process, molten metal contacts with air, causing air swelling. It causes cavities and influences the quality of the product. A proper selection of critical low injection speed can ensure molten metal flows in the barrel smoothly without generating any swelling gas.

Temperature gap between molten metal and barrel wall causes a cold and solid layer on the barrel wall. The function can help operators to observe swelling gas or wrapped gas during feeding and thus to adjust the temperature and the injection speed.

Full Test™ 功能實機模擬壓鑄過程，清楚了解鋁水於成型過程的流動情況，可使用多段速功能，模擬熔湯進入模腔內流動情形，從中觀察，做出對應解決方案，使熔湯達到快射點之前，呈無捲氣飽管狀態。

在冷室壓鑄製程中，料管屬於開放空間，熔湯流動過程中，可能捲入大量氣體而將空氣擠入模腔內，嚴重影響鑄件品質。有效選擇低速射出之臨界速度，使熔湯在料管內流動平順而無捲氣產生。

由於熔湯與料管壁的溫度差，熔湯倒入料管後，會在料管壁形成激冷層而呈固態，在推進的過程中形成捲氣、包氣的情形，經由模擬功能將訊息視覺化，進而調整溫度及射速。



Die casting product 鑄造物



Process for full test 完整測試的過程

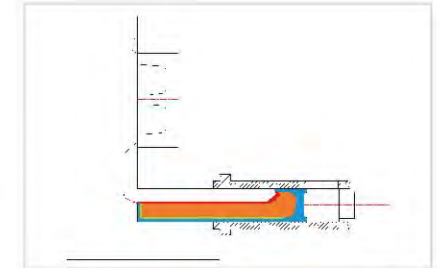

Swelling gas in the barrel 料管內捲氣

## ● Injection Mode (Optional) 射出模式 (選配)

Injection Mode: Soft Start with Single Speed, Multi-stage Speed, and Constant Acceleration.

射出模式有三種：緩啟單速射出、等加速射出、多階段射速，可因應不同鑄件需求

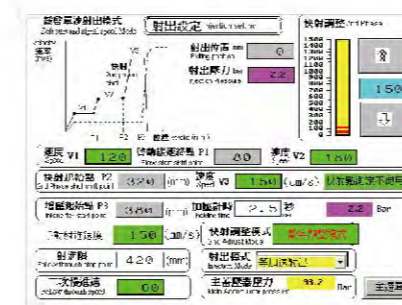

Soft Start with Single Speed 緩啟單速

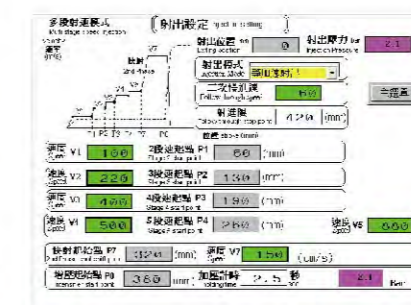

Multi-stage Speed 多段速

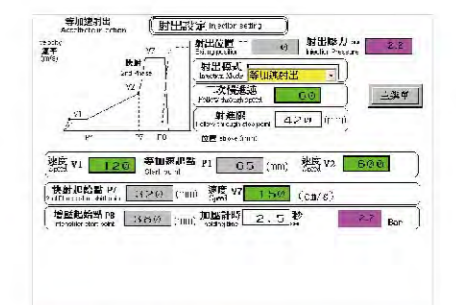

Constant Acceleration 等加速

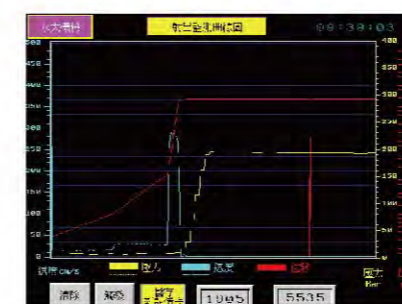

### Standard 標準配備

- First-phase injection / Second-phase injection / Intensified injection
- Color touch screen panel
- Fully P/Q-controlled machine operation
- Adjustable parameters for the injection phases
- Energy-saving P/F valves
- 標準射出有低速、快射、增壓，三個階段控制射出
- 觸控彩色屏幕，操作方便
- 全P/Q控制機械動作
- 可透過人機介面觀察快射、慢進、增壓壓力及速度
- 比例閥除了提升操作方便性更節省15%以上之電能消耗

### Optional 選購配備

- Remote monitoring through Wi-Fi
- Displaying production parameters and curves simultaneously
- Recording production history
- Energy-saving servo control integrates into hydraulic system
- Enhancing casting quality by multi-stage injecting adjustment
- Wi-Fi可即時傳送製程訊息，實現遠端監控功能
- 射出曲線、壓力、速度、位移量，可同時顯示於介面
- 生產履歷記錄功能，可便於追溯歷史參數
- 伺服-液壓系統有效節能
- 多階段射出調整，可減少料管內捲氣；提高壓鑄件品質

# V4N Series

The V4N Series features an integrated injection circuit and two sets of independent accumulators. It provides customers with a more efficient production line and shorter cycle time. Thus it can improve productivity and reduce production cost.

V4N系列壓鑄機有別於V3C系列，其配載一體式射出油路板以及兩組獨立蓄壓器，以全自動化的生產模式、更快速的循環時間，為客戶大幅提升產能、降低生產成本，更可以有效提升壓鑄產品良率及穩定性。

#### Choices of Adjustment Methods:

- Manual Adjustment (Standard)
- Automatic Adjustment (Optional)

#### 射出微調方式：

- 手動調整 (標配)
- 自動調整 (選配)



Manual Adjustment (Standard)  
手動調整 (標配)



Automatic Adjustment (Optional)  
自動調整 (選配)

V4N系列 快速生產 / 品質穩定

#### Two Sets of Independent Accumulators

Injection circuit unit utilizes two sets of independent accumulators. It provides pressure for first-phase, second-phase and intensified injection function. More stable intensified pressure can be offered by an independent intensifying accumulator.

#### Specially Designed Integrated Injection Circuit

The specially-designed manifold minimizes hysteresis of hydraulic response and boosts injection response. Additionally, the integrated injection circuit is easy to maintain and therefore saves more time for maintenance.

#### Achieving Accurate Injection

Injection unit allows adjustments of various parameters, such as pressure built up for first-phase, second-phase intensified-pressure value, and injection pressure value. Sensors in each part of our machine return values of injection speed and pressure to controller. Then the controller compares the difference between the actual injection value and the setting value to do fine-tuning. In addition, operator can understand injection situations through curve shown on the display.

#### 二組獨立蓄壓器 更穩定的增壓壓力

射出迴路採用二組獨立的蓄壓器，分別提供第一段、第二段射出及增壓射出使用。增壓蓄壓器為獨立設計，可提供更穩定的增壓壓力，以及更短的增壓建壓時間。

#### 一體式射出油路 特殊設計的集成化

採用獨特設計的集成化一體式射出油路，可降低液壓反應遲滯現象、射速響應快，且維護容易，可為客戶省下更多維修保養時間。

#### 有助於達成精密射出

射出部份可調整參數包括：一段速、二段速、增壓建壓時間、增壓壓力值、射出壓力值。各部份均配有感知器，可精準的將射出速度及壓力回傳至控制器，經由控制器比對實射值與設定值之誤差，再進行參數微調。操作人員可透過顯示曲線瞭解射出狀況，藉此提昇射出的準確性。

#### Comprehensive Control Functions

- First-phase Injection Speed: Manual / Auto Speed Adjustment
- Second-phase Injection Speed: Manual / Auto Speed Adjustment
- Intensifying Pressure Buildup Time: Manual / Auto Speed Adjustment
- Main Accumulator Pressure Detection / Setting / Safety Device
- Intensifying Accumulator Pressure Detection / Setting / Safety Device
- Pressure Relief Valve for Safety
- Digital Position Feedback / Injection Speed Detect & Display

#### 完善的控制功能

- 一段射速：手動 / 自動反饋調速
- 二段射速：手動 / 自動反饋調速
- 增壓建壓時間：手動 / 自動反饋調速
- 主蓄壓器壓力檢知 / 設置 / 安全裝置
- 增壓蓄壓器壓力檢知 / 設置 / 安全裝置
- 安全洩壓閥
- 數位位置反饋 / 射速檢測 & 顯示

#### E.I.V. Electric Injection Valve (Optional)

- Injection speeds for first-phase, second-phase and intensifying injection are controlled by three E.I.V. valves respectively, which feature automatic corrections and memory functions.
- Injection positioning is controlled by transducer to ensure a highly accurate position.

#### 具有自動修正與記憶功能的E.I.V射出電控閥 (選配)

- 第1段、第2段射出速度與增壓速度分別由三個E.I.V閥控制，具有自動修正與記憶功能。
- 射出位置採用電子尺控制，確保射出位置之精準控制。



# Features Optional 選配

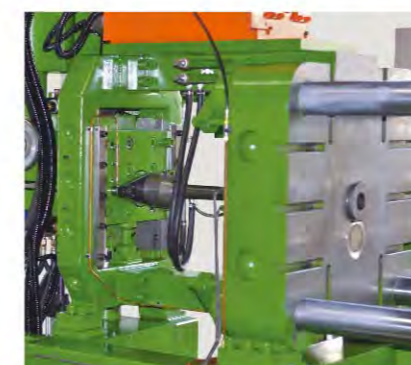

## Two Injection Center

Both injection position and cylinder can be adjusted according to the design of casting or the gate position of mold.

### 雙射出中心

可依據鑄件設計、射料位置的選擇，由機器中心或底部射出，射出缸體可按模具射料口位置移動調整。

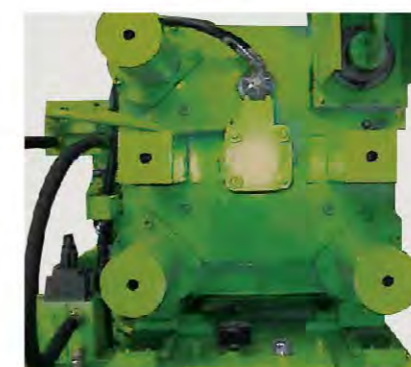

## Automatic Tie Bar Pull Out Device

The design enables an operator to unload the upper tie bar from the front platen. It provides greater convenience especially for dies with hydraulic cores.

### 自動大柱抽取裝置

上側大柱可抽離前機壁，對於具有油壓中子之模具，提供裝卸時的方便性。



## Multi-stage Injection Control

It provides a digital control for Multi-stage Injection Control injection speeds and exhausts air from the barrel and die cavity.

### 多段式射出控制

可提供多段位的射出速度數值化控制模式，可有效排除料管及模腔內空氣。



## Energy-Saving Hydraulic Device

The servo-hydraulic system is more efficient and saves energy reaching up to 35% by precisely controlling power.

### 節能液壓

伺服液壓系統使機台液壓效率更高。機台怠速時，伺服電機暫停運轉，因而不耗能；運行時以超高轉速運行，能夠有效減少電能的使用達到35%。

V3C is our classic model, which has been developed into a complete series of cold chamber die casting machines.

V3C為本公司經典機型，是發展最成熟、應用範圍最廣泛的系列

## V3C系列 經典機型

# V3C Series

The 150T die casting machine is a small model. It provides 150T clamping force and die platen with size 730 mm x 730 mm. Its highest injection speed is 7 m/sec.

The 650T and 800T machines are state-of-the-art models that feature optimum mechanical structure and oversized die platen. These models surpass the limitation of small platen size of other machines. The high speed solenoid, a powerful device to boost casting techniques, is standard equipment.

DC-150屬於小型機種，精巧快捷、產速快，本機具有150噸鎖模力，最高射出速度可達 7 m/sec；機壁尺寸為 730 mm x 730 mm。

650噸以及800噸壓鑄機皆具備超大機壁尺寸，同時突破舊型機模面小的限制。此外，快射電控閥列為標準配備，對於鑄造技術及參數調整有很大助益。

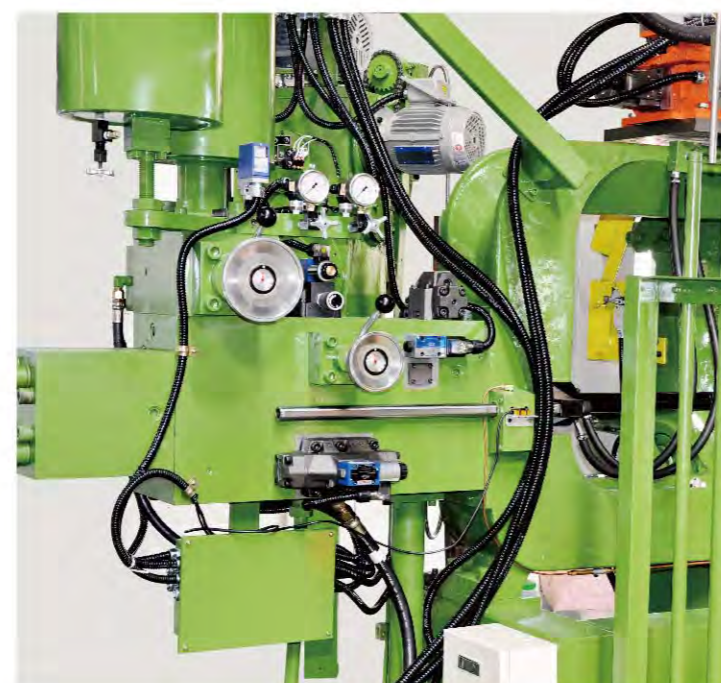

# Features Standard 標配



## Hydraulic System

Main pressure control system adopts variable and proportional valves to increase efficiency and to extend service life.

### 液壓系統

總壓控制採用無段式比例閥，具高效率且使用壽命長。使用大同馬達及日本TOKIMEC的油泵，穩定性及耐用度受到普遍的肯定。

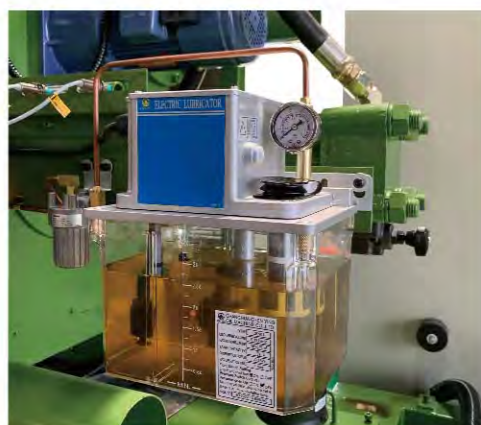

## Automatic Lubricator

All toggle points are lubricated predominantly with slideway oil No.68. The lubrication pressure is 20 kg/cm<sup>2</sup>.

### 自動注油器

機器各部位曲手之活動點皆施以滑道油68潤滑，注油壓力 20 kg/cm<sup>2</sup>，確保運作時無潤滑不足之虞。



## Self-lubricating Bushings

Toggles are equipped with self-lubricating bushings. It provides high accuracy, reduces oil consumption, and offers tolerance of toggles under extremely high pressures.

### 自潤型銅套

全系列機種之曲手使用自潤型銅套，可確保長久精度，減少注油頻率，並增加曲手在高壓情況下的耐受度。



## Piston-type Accumulator

This design shortens the time for intensifying pressure and increases density for workpieces. Since this type of accumulator is not affected by oil impurity, it reduces maintenance costs.

### 活塞式蓄壓器

全系列機種採用活塞式蓄壓器，可積蓄壓力高達210kg/cm<sup>2</sup>，並且直接作高壓輸出，可縮短增壓建壓時間，以提升鑄品密緻度，不受雜質影響，節省維修成本。



## Safety Door

The machine stops immediately when the operator opens the safety door. This can reduce the failure rate by protecting the machine from environmental pollution.

### 安全門

正反兩側安全門包覆，當安全門打開時，本機所有動作立刻停止，確保人員的安全及機器正常運行，減少環境對機器汙染，進而降低機器故障率。



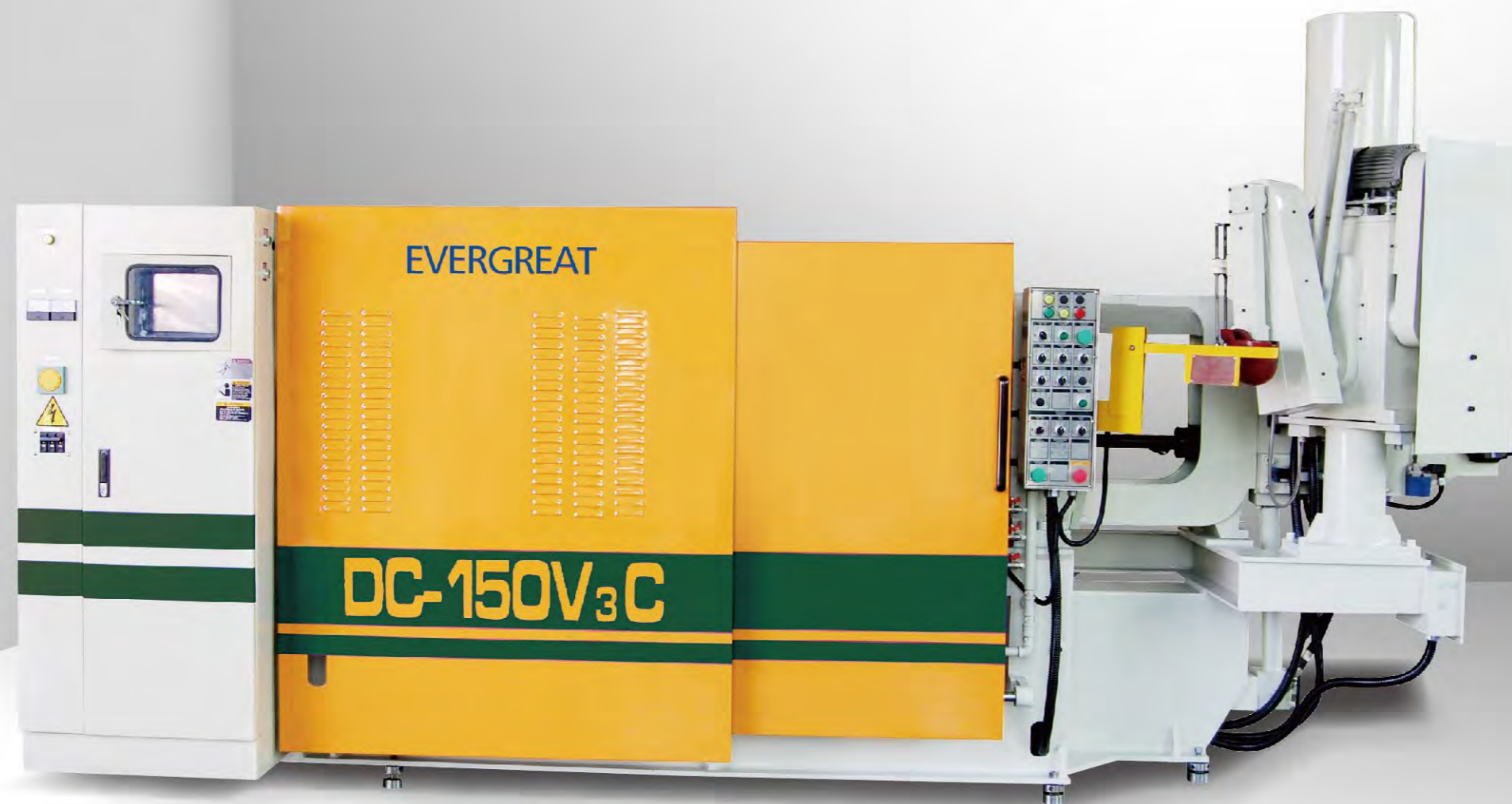

# DC-150

Suitable for V3C series

適用於V3C系列

|                     |         |                     |
|---------------------|---------|---------------------|
| Clamping force      | 鎖模力     | 150 Ton             |
| Die height          | 夾模厚度    | 200 - 500 mm        |
| Tie bar distance    | 柱內尺寸    | 465 x 465 mm        |
| Max. weight of shot | 最大實射出重量 | 1.64 kg             |
| Max. casting area   | 最大鑄造面積  | 426 cm <sup>2</sup> |
| Electricity         | 所需馬力    | 15 kw               |

Dimensions of Platen 模面尺寸圖

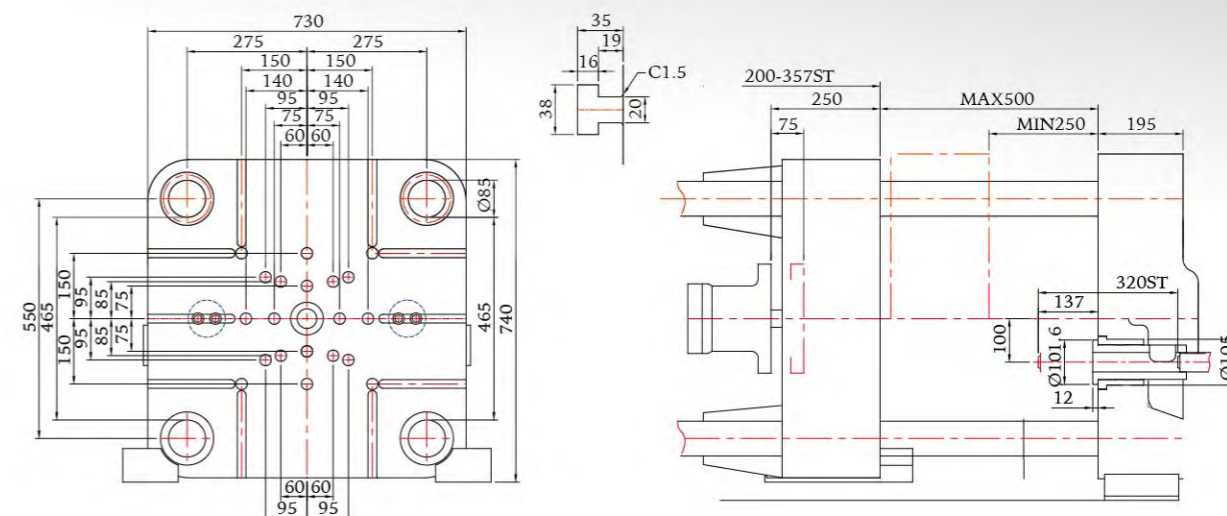



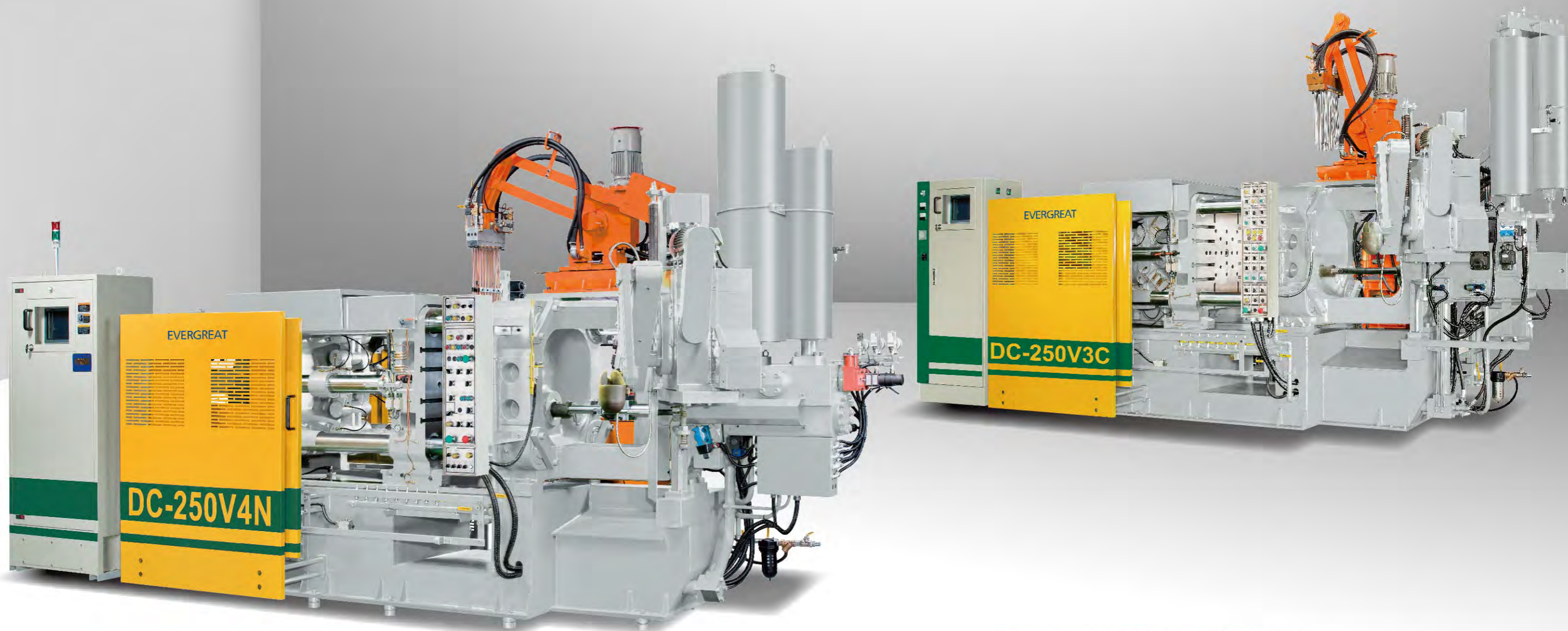

# DC-250

Suitable for V3C / V4N series

適用於V3C / V4N系列

|                             |                     |
|-----------------------------|---------------------|
| Clamping force 鎖模力          | 250 Ton             |
| Die height 夾模厚度             | 250 - 600 mm        |
| Tie bar distance 柱內尺寸       | 585 x 585 mm        |
| Max. weight of shot 最大實射出重量 | 2.75 kg             |
| Max. casting area 最大鑄造面積    | 714 cm <sup>2</sup> |
| Electricity 所需馬力            | 22.5 kw             |

Dimensions of Platen 模面尺寸圖

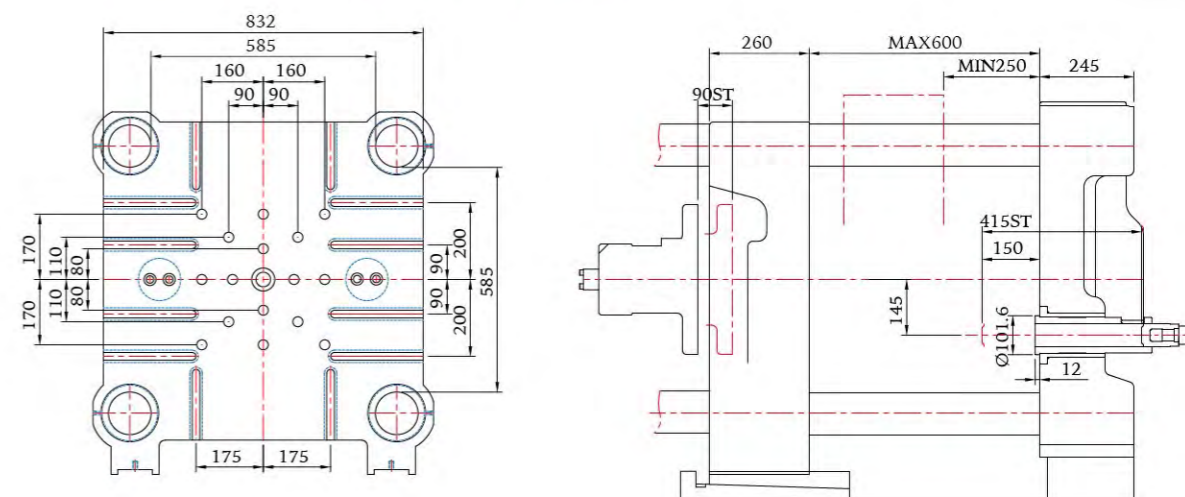



# DC-420

Suitable for V4N series

適用於V4N系列

|                     |         |                      |
|---------------------|---------|----------------------|
| Clamping force      | 鎖模力     | 420 Ton              |
| Die height          | 夾模厚度    | 300 - 700 mm         |
| Tie bar distance    | 柱內尺寸    | 650 x 650 mm         |
| Max. weight of shot | 最大實射出重量 | 4.18 kg              |
| Max. casting area   | 最大鑄造面積  | 1036 cm <sup>2</sup> |
| Electricity         | 所需馬力    | 22.5 kw              |

Dimensions of Platen 模面尺寸圖

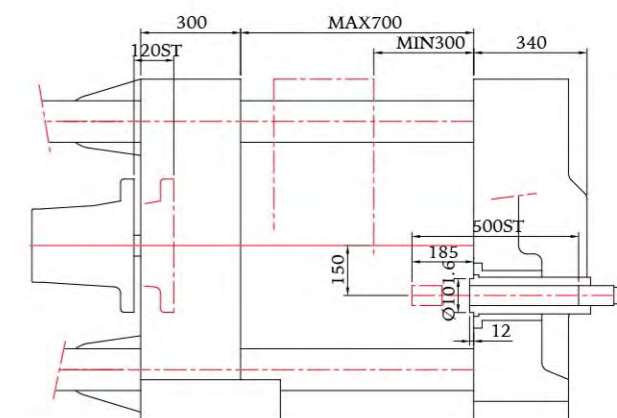
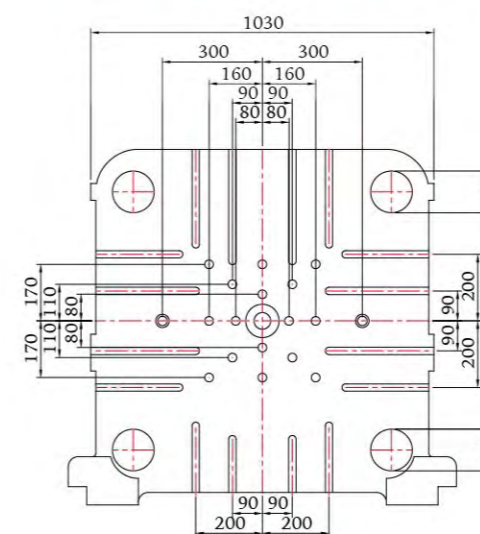



# DC-650

Suitable for V3C series

適用於V3C系列

|                     |         |                      |
|---------------------|---------|----------------------|
| Clamping force      | 鎖模力     | 650 Ton              |
| Die height          | 夾模厚度    | 350 - 900 mm         |
| Tie bar distance    | 柱內尺寸    | 850 x 850 mm         |
| Max. weight of shot | 最大實射出重量 | 7.68 kg              |
| Max. casting area   | 最大鑄造面積  | 1522 cm <sup>2</sup> |
| Electricity         | 所需馬力    | 37.5 kw              |

Dimensions of Platen 模面尺寸圖

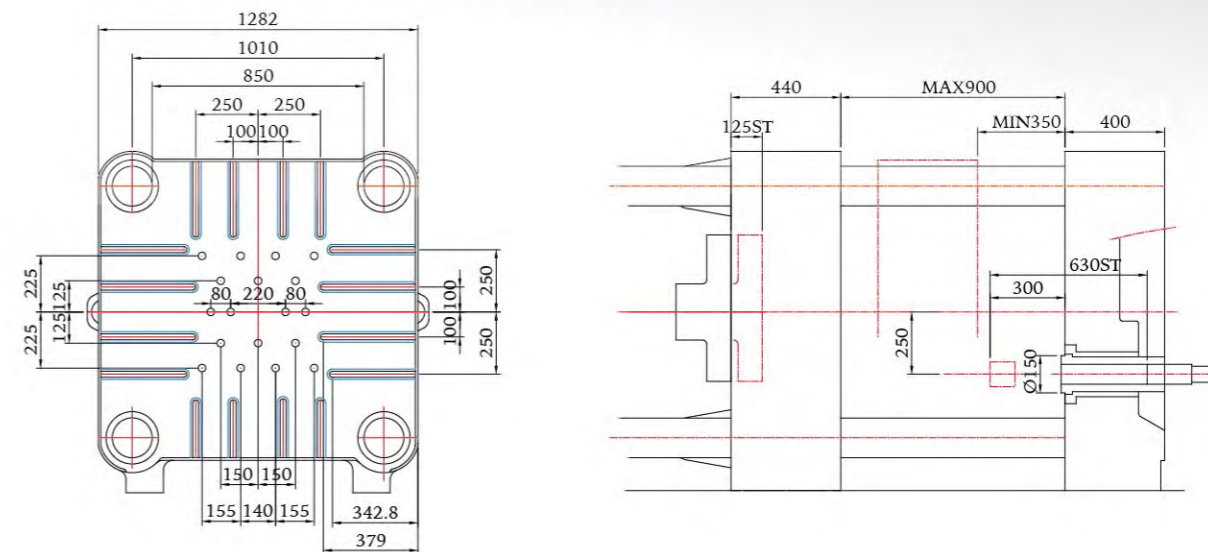

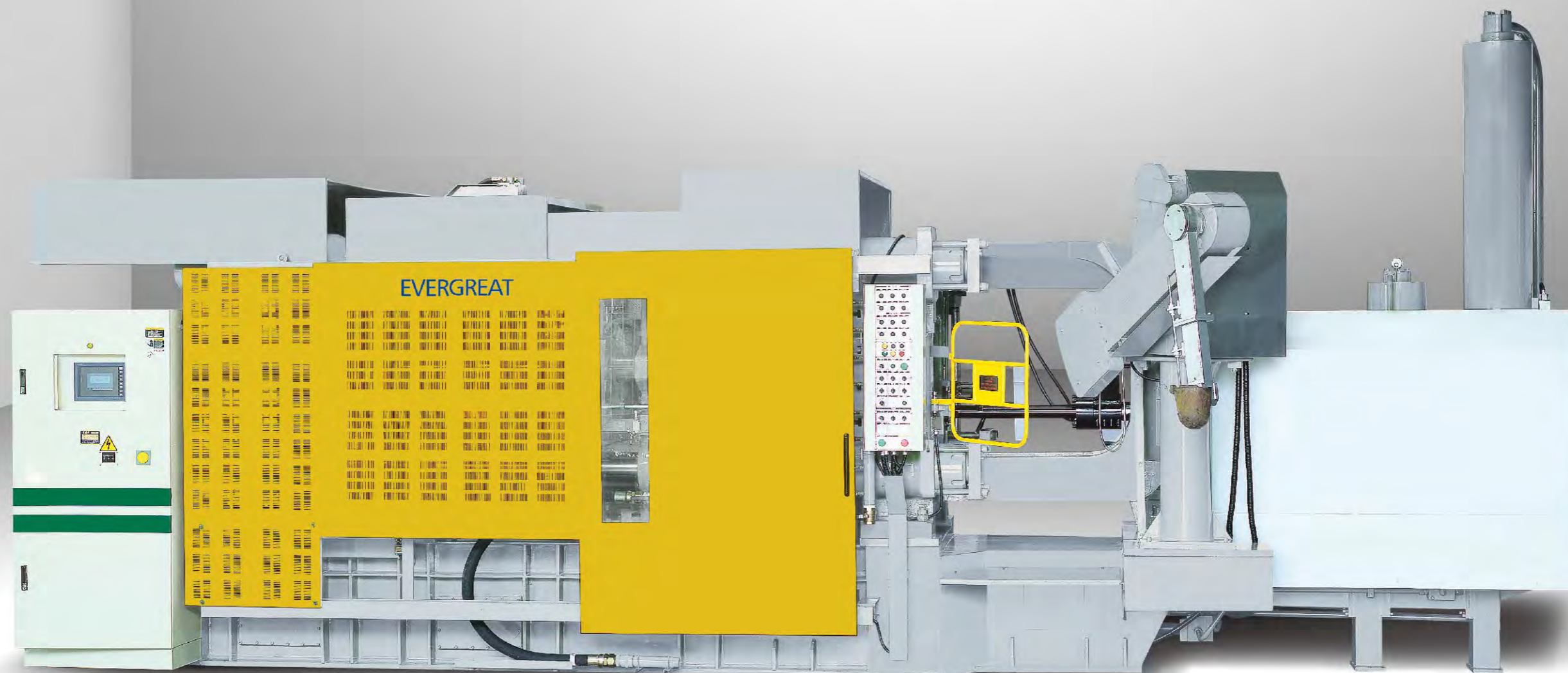

# DC-800

Suitable for V3C series

適用於V3C系列

|                     |         |                      |
|---------------------|---------|----------------------|
| Clamping force      | 鎖模力     | 800 Ton              |
| Die height          | 夾模厚度    | 400 - 950 mm         |
| Tie bar distance    | 柱內尺寸    | 950 x 950 mm         |
| Max. weight of shot | 最大實射出重量 | 10.7 kg              |
| Max. casting area   | 最大鑄造面積  | 2088 cm <sup>2</sup> |
| Electricity         | 所需馬力    | 45 kw                |

Dimensions of Platen 模面尺寸圖

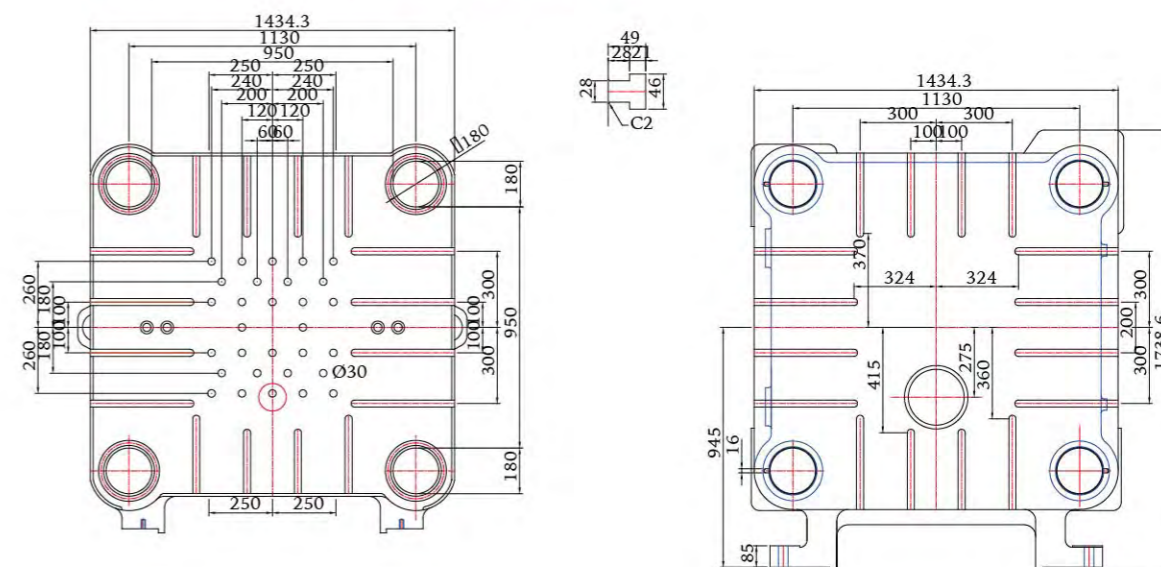

## Ladle 給湯機

### DAL Type

- Two sets of worm drive system provide smooth operation
- Integrated design box improves accuracy for ladling process

### DAL 型

- 雙蝸桿傳動系統可加強手臂行進及運轉平穩性。
- 箱體一體成型提高機器精準度。



DAL Type



AL Type



CL Type

## Sprayer 噴霧機

### SPV-N Type

- 3 areas for setting spraying and blowing on both sides.
- Saving doses while spraying due to nozzle-type sprayer.

### SPV-N 型

- 活動模與固定模分別有三個區域設置噴霧與吹氣。
- 噴嘴式噴頭可節省劑量的使用量，分別執行噴霧與吹氣。



SPV-N Type



SPV Type



SPV-800 Type

## Extractor 取出機

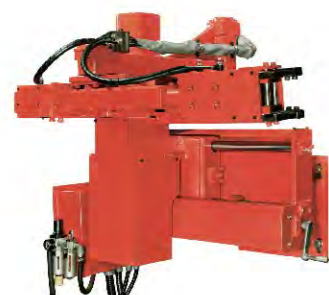

EXJ Type

## Lubricating Device 潤滑裝置



Lubricating Device for Plunger Oil  
柱塞油潤滑裝置(打油機)



Lubricating Device for Shot Beads  
顆粒機

## Ladle 給湯機

|                            | Unit 單位 | AL / DAL-15                       | AL / DAL-25 | AL / DAL-42 | CL-650    | CL-800  |
|----------------------------|---------|-----------------------------------|-------------|-------------|-----------|---------|
| Applicable models 適用機型     |         | DC-150                            | DC-250      | DC-420      | DC-650    | DC-800  |
| Dosing weight 可汲湯量         | kg      | 0.2 - 1.5                         | 0.4 - 2.5   | 0.4 - 3.5   | 0.5 - 6   | 0.5 - 8 |
| Metal weight tolerance 取湯差 | %       | ±2                                |             |             |           |         |
| Drive electric motor 驅動電機  | kW      | 0.75 / 0.4                        |             |             | 1.5 / 0.4 |         |
| Ladle size 可用湯勺規格          | kg      | 0.5 / 0.8 / 1.5 / 2.0 / 2.5 / 3.5 |             |             | 5 / 7 / 8 |         |

## Sprayer 噴霧機

|                          | Unit 單位            | SPV-15          | SPV-25    | SPV-42    | SPV-800         |
|--------------------------|--------------------|-----------------|-----------|-----------|-----------------|
| Applicable models 適用機型   |                    | DC-150          | DC-250    | DC-420    | DC-650 / DC-800 |
| # of spraying tube 噴霧管   |                    | 34              | 34        | 34        | 50              |
| # of blowing tube 吹氣管    |                    | 14              | 14        | 14        | 23              |
| Air consumption 空氣消耗量    | NL/min             | 140             |           |           |                 |
| Air reserve tank 儲氣桶     | Liter              | 250 - 300       | 250 - 300 | 250 - 300 | 400             |
| Traveling stroke 上下行程    | mm                 | 1000            | 1200      | 1320      | 1320            |
| Pneumatic source 空壓源     | kg/cm <sup>2</sup> | 4 - 6 (1" port) |           |           |                 |
| Driving power source 驅動源 | kW                 | 0.75            | 0.75      | 0.75      | 1.5             |

|                          | Unit 單位            | SPVN-15         | SPVN-25 | SPVN-42 |
|--------------------------|--------------------|-----------------|---------|---------|
| Applicable models 適用機型   |                    | DC-150          | DC-250  | DC-420  |
| # of nozzle 噴嘴           |                    | 16              | 28      | 36      |
| # of blowing tube 吹氣管    |                    | 30              | 30      | 38      |
| Air consumption 空氣消耗量    | NL/min             | 110             |         |         |
| Traveling stroke 上下行程    | mm                 | 1000            | 1200    | 1320    |
| Pneumatic source 空壓源     | kg/cm <sup>2</sup> | 4 - 6 (1" port) |         |         |
| Driving power source 驅動源 | kW                 | 0.75            | 1.5     | 1.5     |

## Extractor 取出機

|                          | Unit 單位            | EXJ-15          | EXJ-25  | EXJ-42  | EXJ-65  | EXJ-80   |
|--------------------------|--------------------|-----------------|---------|---------|---------|----------|
| Applicable models 適用機型   |                    | DC-150          | DC-250  | DC-420  | DC-650  | DC-800   |
| Component weight 鑄件重量    | kg                 | 1.5             | 2.5     | 3.5     | 6       | 8        |
| Plunger diameter 夾取直徑    | mm                 | 45 / 50 / 60    | 50 - 70 | 60 - 80 | 70 - 90 | 80 - 120 |
| Arm driving motor 手臂驅動馬達 | kW                 | 0.4             |         |         |         |          |
| Pneumatic source 空壓源     | kg/cm <sup>2</sup> | 4 - 6 (1" port) |         |         |         |          |

# Specification Table

規格表

| Model                      | 機型                          | UNIT               | DC-150              |           |           | DC-250              |           |           | DC-420              |           |            | DC-650             |            |            | DC-800             |            |             |
|----------------------------|-----------------------------|--------------------|---------------------|-----------|-----------|---------------------|-----------|-----------|---------------------|-----------|------------|--------------------|------------|------------|--------------------|------------|-------------|
| Control unit               | 電氣系統                        |                    | PLC + MMI           |           |           | PLC + MMI           |           |           | PLC + MMI           |           |            | PLC + MMI          |            |            | PLC + MMI          |            |             |
| Shot unit                  | 射出方式                        |                    | 3 phases            |           |           | 3 phases            |           |           | 3 phases            |           |            | 4 phases           |            |            | 4 phases           |            |             |
| Multi-stage injection      | 多段射出                        |                    | X                   |           |           | Optional 選配         |           |           | Optional 選配         |           |            | Optional 選配        |            |            | Optional 選配        |            |             |
| CLAMPING MECHANISM<br>鎖模機構 | Clamping force              | Ton                | 150                 |           |           | 250                 |           |           | 420                 |           |            | 650                |            |            | 800                |            |             |
|                            | Die platen                  | mm                 | 730 x 730           |           |           | 890 x 890           |           |           | 1000 x 1000         |           |            | 1280 x 1280        |            |            | 1432 x 1432        |            |             |
|                            | Tie bar distance            | mm                 | 465 x 465           |           |           | 585 x 585           |           |           | 650 x 650           |           |            | 850 x 850          |            |            | 950 x 950          |            |             |
|                            | Die stroke                  | mm                 | 357                 |           |           | 435                 |           |           | 470                 |           |            | 660                |            |            | 760                |            |             |
|                            | Die height                  | mm                 | 250 - 500           |           |           | 250 - 600           |           |           | 300 - 700           |           |            | 350 - 900          |            |            | 400 - 950          |            |             |
| INJECTING MECHANISM<br>射出  | Injection force             | Ton                | 18.2                |           |           | 27                  |           |           | 35                  |           |            | 54.5               |            |            | 63                 |            |             |
|                            | Intensifying rate           |                    | 2.1                 |           |           | 2.55                |           |           | 2.3                 |           |            | 2.55               |            |            | 2.55               |            |             |
|                            | Injection stroke            | mm                 | 355                 |           |           | 420                 |           |           | 500                 |           |            | 630                |            |            | 680                |            |             |
|                            | Plunger tip penetration     | mm                 | 150                 |           |           | 160                 |           |           | 185                 |           |            | 300                |            |            | 300                |            |             |
|                            | Shot position               | mm                 | -100                |           |           | -145                |           |           | -150                |           |            | -250               |            |            | -250               |            |             |
|                            | Injection pressure          | kg/cm <sup>2</sup> | 110 - 130           |           |           | 110 - 140           |           |           | 110 - 140           |           |            | 110 - 140          |            |            | 110 - 140          |            |             |
|                            | Max injection velocity (up) | m/s                | 7                   |           |           | 7                   |           |           | 7                   |           |            | 7                  |            |            | 7                  |            |             |
|                            | Available plunger diameter  | mm                 | 45 / 50 / 60        |           |           | 50 / 60 / 70        |           |           | 60 / 70 / 80        |           |            | 70 / 80 / 90       |            |            | 80 / 90 / 100      |            |             |
| EJECTING MECHANISM<br>押出   | Ejecting force              | Ton                | 7.9                 |           |           | 12.3                |           |           | 20                  |           |            | 31                 |            |            | 36                 |            |             |
|                            | Ejecting stroke             | mm                 | 75                  |           |           | 90                  |           |           | 90                  |           |            | 125                |            |            | 125                |            |             |
| CORE SYSTEM<br>中子          | Core no.1 outlet            | pt                 | 1/2" x 2            |           |           | 3/4" x 2            |           |           | 3/4" x 2            |           |            | 3/4" x 2           |            |            | 3/4" x 2           |            |             |
|                            | Core no.2 outlet            | pt                 | 1/2" x 2 (Optional) |           |           | 3/4" x 2 (Optional) |           |           | 3/4" x 2 (Optional) |           |            | 3/4" x 1           |            |            | 3/4" x 1           |            |             |
|                            | Core no.3 outlet            | pt                 | X                   |           |           | X                   |           |           | X                   |           |            | 3/4" x 1           |            |            | 3/4" x 1           |            |             |
| CASTING CAPACITY<br>鑄造能力   | Plunger diameter            | mm                 | Ø45                 | Ø50       | Ø60       | Ø50                 | Ø60       | Ø70       | Ø60                 | Ø70       | Ø80        | Ø70                | Ø80        | Ø90        | Ø80                | Ø90        | Ø100        |
|                            | Injection pressure          | kg/cm <sup>2</sup> | 522 - 1056          | 422 - 856 | 293 - 594 | 687 - 1374          | 477 - 954 | 350 - 700 | 600 - 1200          | 441 - 882 | 337 - 674  | 707 - 1416         | 541 - 1084 | 427 - 857  | 600 - 1200         | 480 - 960  | 385 - 770   |
|                            | Casting area                | cm <sup>2</sup>    | 118 - 239           | 146 - 296 | 210 - 426 | 181 - 363           | 262 - 524 | 357 - 714 | 292 - 584           | 397 - 794 | 518 - 1036 | 459 - 919          | 599 - 1201 | 775 - 1522 | 660 - 1320         | 830 - 1660 | 1040 - 2088 |
|                            | Injecting volume            | cm <sup>3</sup>    | 362                 | 447       | 644       | 540                 | 777       | 1058      | 904                 | 1230      | 1607       | 1788               | 2336       | 2956       | 2635               | 3340       | 4120        |
|                            | Injecting weight            | kgs                | 0.92                | 1.16      | 1.64      | 1.4                 | 2.02      | 2.75      | 2.35                | 3.2       | 4.18       | 4.64               | 6.07       | 7.68       | 6.8                | 8.7        | 10.7        |
| COOLER<br>冷卻水              | Water inlet                 | Rc PT              | 1"                  |           |           | 1"                  |           |           | 1"                  |           |            | 1-1/4"             |            |            | 1-1/4"             |            |             |
|                            | Water outlet                | Rc PT              | 2"                  |           |           | 2"                  |           |           | 2"                  |           |            | 2-1/2"             |            |            | 2-1/2"             |            |             |
|                            | Hydraulic cooler in         | Rc PT              | 1"                  |           |           | 1"                  |           |           | 1"                  |           |            | 1"                 |            |            | 1"                 |            |             |
|                            | Hydraulic cooler out        | Rc PT              | 1"                  |           |           | 1"                  |           |           | 1"                  |           |            | 1"                 |            |            | 1"                 |            |             |
|                            | Die water valve (fix)       |                    | 3/8" x 5            |           |           | 3/8" x 7            |           |           | 3/8" x 7            |           |            | 3/8" x 11          |            |            | 3/8" x 11          |            |             |
|                            | Die water valve (mov)       |                    | 3/8" x 5            |           |           | 3/8" x 7            |           |           | 3/8" x 7            |           |            | 3/8" x 15          |            |            | 3/8" x 15          |            |             |
|                            | Hydraulic cooler flow       | L/min              | 40                  |           |           | 40                  |           |           | 40                  |           |            | 80                 |            |            | 100                |            |             |
|                            | Die cooler flow             | L/min              | 25 - 50             |           |           | 30 - 70             |           |           | 30 - 70             |           |            | 50 - 90            |            |            | 70 - 150           |            |             |
| MOTOR<br>馬達                | Motor                       | kw                 | 15                  |           |           | 22.5                |           |           | 22.5                |           |            | 37.5               |            |            | 45                 |            |             |
|                            | Power source                | V                  | AC220 / 380         |           |           | AC220 / 380         |           |           | AC220 / 380         |           |            | AC220 / 380        |            |            | AC220 / 380        |            |             |
| MACHINE DIMENSIONS<br>機械   | Size (L x W x H)            | mm                 | 4600 x 1740 x 2300  |           |           | 5030 x 1800 x 2040  |           |           | 6500 x 2200 x 2500  |           |            | 7500 x 2600 x 2780 |            |            | 8600 x 3600 x 3100 |            |             |
|                            | Weight                      | Ton                | 6                   |           |           | 10.5                |           |           | 16                  |           |            | 25                 |            |            | 39                 |            |             |
|                            | Hydraulic oil (optional)    | L                  | 600                 |           |           | 800                 |           |           | 800                 |           |            | 1200               |            |            | 1600               |            |             |